



2017 - 2018

**NSW & ACT DISTRICT LASER ASSOCIATION  
LASER, LASER RADIAL AND LASER 4.7  
NSW METROPOLITAN CHAMPIONSHIP**

17<sup>th</sup> and 18<sup>th</sup> March 2018

**Drummoyne Sailing Club**

The Organising Authority is the NSW & ACT District Laser Association  
in association with Drummoyne Sailing Club

# SAILING INSTRUCTIONS

**DP.** Discretionary Penalty. The notation [DP] in a rule of these Instructions means that the penalty for a breach of that rule may, at the discretion of the Protest Committee, be less than disqualification.

**NP.** The notation [NP] in a rule of these Instructions means that an/the incident shall not be protestable by a competitor. This changes RRS 60.1(a).

**SP.** Standard Penalty. The notation [SP] in a rule of these Instructions means that for some breaches of the rules the Race Committee may apply a standard penalty without a hearing. The Race Committee may still protest a competitor when they consider the SP is inappropriate. A competitor may request a redress if they believe the application of the SP improper. The SP for this regatta is 5 points to the competitors finishing position, in the race closest in time to the incident. When applied the scores of other competitors shall not be changed. This changes RRS 63.1 and A5.

## 1. RULES

The Regatta will be governed by the Rules of Sailing, the Australian Sailing Prescriptions and Part 2 of the Special Regulations of Australian Sailing, the rules and by-laws of the International Laser Class Association (ILCA), the Navigation Collision Regulations of NSW (Instruction 22), the Notice of Race (all as amended by these Sailing Instructions) and these Sailing Instructions.

## 2. ELIGIBILITY AND ENTRY

- 2.1 Entries shall be lodged in accordance with NoR Clause 3.
- 2.2 All competitors shall complete registration with the Organising Authority.
- 2.3 All competitors shall be current financial members of a district of the ILCA and of a yacht or sailing club affiliated with a National Authority.
- 2.4 Eligibility for youth age groups shall be the age on 31 December 2018. Eligibility for all other age groups shall be the age on 17 March 2018.

## 3. NOTICES TO COMPETITORS

Notices to Competitors will be posted on the official Regatta Notice Board located in the Sailors' Bar at Drummoyne Sailing Club (DSC).

#### **4. CHANGES IN SAILING INSTRUCTIONS**

Any change to the Sailing Instructions will be posted at least two hours before the first race on the day it will take effect, except that any change in the schedule of races will be posted by 1900 on the day before it will take effect.

#### **5. SIGNALS MADE ASHORE**

- 5.1 Signals made ashore will be displayed on the DSC flag mast located at the eastern corner of the sea wall in front of the club.
- 5.2 When flag AP is displayed ashore, "one minute" is replaced with "not less than 30 minutes" in race signal AP.

#### **6. RACING SCHEDULE**

6.1 The racing schedule follows:

<b>Event</b>	<b>Day</b>	<b>Date</b>	<b>Time</b>
Briefing	Saturday	17 Mar 18	1130 hours
Racing	Saturday	17 Mar 18	First Warning Signal at 1330 hours. Subsequent starts shall be made ASAP after the preceding race
Racing	Sunday	18 Mar 18	First Warning Signal at 1100 hours. Subsequent starts shall be made ASAP after the preceding race

- 6.2 A maximum of six races are to be conducted for the Championship.
- 6.3 No Warning Signal shall be made after 1530 hours Sunday 18 March 2018.

#### **7. FLEETS**

- 7.1. The Laser Standard division shall sail as one fleet.
- 7.2. The Laser Radial division shall sail as one fleet.
- 7.3. The Laser 4.7 division shall sail as one fleet.
- 7.4. The Race Committee may decide to change the fleet structures based on numbers. Any decision of the Race Committee regarding changes to divisions shall be communicated as a Change to Sailing Instructions.

#### **8. FLEET FLAGS**

- 8.1. The Laser Standard fleet flag will be a white flag with a red Laser emblem.
- 8.2. The Laser Radial fleet flag will be a green flag with a red Laser emblem.
- 8.3. The Laser 4.7 fleet flag will be a yellow flag with a 4.7 emblem.

#### **9. RACING AREA**

The racing area will be the waters of Western Sydney Harbour and the Parramatta River in the vicinity of DSC.

#### **10. COURSES**

See Attachment A.

#### **11. MARKS**

- 11.1. Marks 1, 2, 3, 4, 5 and 6 will be yellow inflatable cylinders with a Cherub insignia.
- 11.2. The Start Mark will be a stick mark with an orange flag.
- 11.3. The Finish Mark will be a stick mark with a blue flag.

#### **12. THE START**

- 12.1. The starting order for Race 1 will be the Laser 4.7 fleet, followed by the Laser Radial fleet, and followed by the Laser Standard fleet. This may be amended for subsequent races by the Race Officer.

- 12.2. Succeeding fleets may be started any time after the preceding fleet.
- 12.3. The starting line will be between the flag mast displaying an orange flag on the Race Committee boat at the starboard end and the port end Start Mark.
- 12.4. [NP] Boats who's Warning Signal has not been made shall avoid the starting area and all boats who's Warning Signal has been made.
- 12.5. [NP] A boat starting later than four minutes after her starting signal will be scored "Did Not Start". This amends rule A4.1.
- 12.6. [NP] Use of engines by a race committee boat to hold position shall not be an improper action of the race committee. Any effects will not be grounds for granting redress. This alters Rule 60.1(b) and 62.

### **13. CHANGE OF COURSE**

To change the next leg of the course, the Race Committee will move the original mark (or the finishing line) to a new position.

### **14. THE FINISH**

- 14.1. The finishing line will be between a flag mast displaying an orange flag on the race committee boat at the port end and the starboard end Finish Mark.
- 14.2. [NP] Use of engines by a Race Committee boat to hold position shall not be an improper action of the Race Committee. Any effects will not be grounds for granting redress. This alters RRS 60.1(b) and 62

### **15. PENALTY SYSTEM**

The Protest Committee may go on the water and to encourage boats to take penalties afloat jury members will blow a whistle when they see what they believe to be a breach of a rule.

### **16. RETIREMENT**

- 16.1. A competitor who retires from a race, either before or after finishing, shall:
  - a. notify the Race Committee aboard the race committee boat; and
  - b. sign off before the end of Protest Time.

### **17. TIME LIMIT**

- 17.1. The time limit for the first boat to complete the course and finish correctly in each fleet will be 90 minutes.
- 17.2. Boats failing to finish within 20 minutes after the first boat of the same fleet sails the course and finishes will be scored Did Not Finish without a hearing. This changes Rules 35, A4 and A5.
- 17.3. [NP] If no boat has rounded the first mark within 30 minutes from the start the race will be abandoned.

### **18. ARBITRATION**

Appendix T will apply, amended so that an Arbitrator may be part of a Protest Committee in any protest subsequent to arbitration.

### **19. PROTESTS AND REQUEST FOR REDRESS**

- 19.1. Protests shall be written on forms available from the race office. Protests shall be delivered there within the protest time limit.
- 19.2. The protest time limit is 60 minutes after the last boat has finished the last race of the day.
- 19.3. Notices will be posted within 15 minutes of the protest time limit to inform competitors of the hearings in which they are parties or named as witnesses. Hearings will be held

in the protest room located in the clubhouse. The Protest Committee will hear protests in approximately the order of receipt and as soon as possible.

- 19.4. Notices of protests by the Race Committee or Protest Committee will be posted to inform boats under Rule 61.1(b).
- 19.5. For the purpose of Rule 64.3(b) the 'authority responsible' is the measurer appointed by the Organising Authority.
- 19.6. Rule 66 is amended by adding this sentence: "On the last day of racing, a party to the hearing may ask for a reopening no later than 30 minutes after being informed of the decision."
- 19.7. On the last scheduled day of racing a request for redress based on a Protest Committee decision shall be delivered not later than 30 minutes after the decision was posted. This changes Rule 62.2.

## **20. SCORING**

- 20.1. Six races are scheduled, of which three completed races are required to constitute a series.
- 20.2. When four or more races are completed, the worst will be discarded.
- 20.3. All age and gender divisions will be awarded based on the ranking of competitors in the overall results.

## **21. SAFETY REGULATION, SIGNING ON AND SIGNING OFF**

- 21.1. [SP] All skippers shall sign on prior to going afloat for racing in any session.
- 21.2. [SP] All skippers shall sign off within the protest time limit.
- 21.3. Two sign on and off systems will be employed. Sailors will use one of either:
  - a. A paper sign on and off sheet located outside the DSC Sailors' Bar.
  - b. An SMS system. The SMS number is 0477 647 537. Sailors using this system must sign on and off to this number. No acknowledgement will be made of receipt. The SMS shall contain the sail number and the words "sign on" or "sign off". Multiple boats may be included on an SMS, noting that the sender takes responsibility for the accuracy of the SMS.
- 21.4. [DP] [NP] A competitor who retires from a race, either before or after finishing, shall:
  - a. notify the Race Committee aboard the race committee boat; and
  - b. sign off before the end of Protest Time.

## **22. [DP] [NP] HARBOUR SAFETY**

- 22.1. Competitors shall comply with the Navigation Collision Regulations of NSW. These regulations permit ferries flying the orange diamond priority over sail.
- 22.2. To comply with Instruction 22.1 competitors shall keep 200m clear ahead and 30m from the sides and stern of ferries.
- 22.3. Attachment B contains direction and diagrams pertaining to the Navigation Collision Regulations of NSW.
- 22.4. Boats shall not pass between any fixed mooring and the nearest shoreline after the preparatory signal and throughout the duration of the race. That is, all moorings should be passed on the channel side.
- 22.5. All navigation marks are obstructions and shall be passed on their designated side.
- 22.6. Prohibited areas deemed to be continuing obstructions are bounded by:
  - a. Snapper Island and the north cardinal mark.
  - b. Spectacle Island and the red channel mark to the north.

- c. Spectacle Island and the green channel pile to the south.
- d. Spectacle Island and the fixed piles to the north-west.

**23. REPLACEMENT OF EQUIPMENT**

Substitution of damaged or lost spars, boards, sail or hull will not be permitted unless approved by the Race Committee. Requests for substitution shall be made in writing to the committee at the first reasonable opportunity.

**24. EQUIPMENT AND MEASUREMENT CHECKS**

A boat or equipment may be inspected at any time for compliance with the ILCA Class Rules and Australian Sailing Special Regulations, Part 2 Off The Beach Boats.

**25. [DP] [NP] SUPPORT BOATS**

Team leaders, coaches and other support personnel shall stay 100 metres outside areas where boats are racing from the time of the preparatory signal until all boats have finished or retired or the Race Committee signals a postponement, general recall or abandonment, unless exception is granted by express authority from the Race Committee.

**26. RUBBISH DISPOSAL**

No rubbish is to be dumped into the water. All rubbish is to be handed to official boats or taken ashore.

**27. [DP] [NP] RADIO COMMUNICATION**

Except in an emergency, a boat shall neither make radio transmissions while racing nor receive radio communications not available to all boats. This restriction also applies to mobile telephones.

**28. PRIZES**

- 28.1. Prizes will be awarded to the Division winners.
- 28.2. Other prizes may also be awarded at the discretion of the Organising Authority.

**29. DISCLAIMER OF LIABILITY**

Competitors participate in the Regatta entirely at their own risk. See rule 4, Decision to Race. The Organising Authority will not accept any liability for material damage or personal injury or death sustained in conjunction with or prior to, during, or after the Regatta. Attention is drawn to Clause 15 of the Notice of Race.

**30. [NP] INSURANCE**

Each participating boat shall be insured with a valid third party liability insurance with a minimum cover of AUS \$10,000,000. Signing the entry and declaration form confirms currency of this insurance.

**31. RIGHTS TO USE NAME AND LIKENESS**

By participating in this event, competitors automatically grant to the Organising Authority, the event sponsors and DSC the right, in perpetuity, to make, use and show at their discretion any photography, audio and video recordings and any other reproductions of them made at the venue or on the water from the time of their arrival at the venue until their final departure after the event, without compensation.



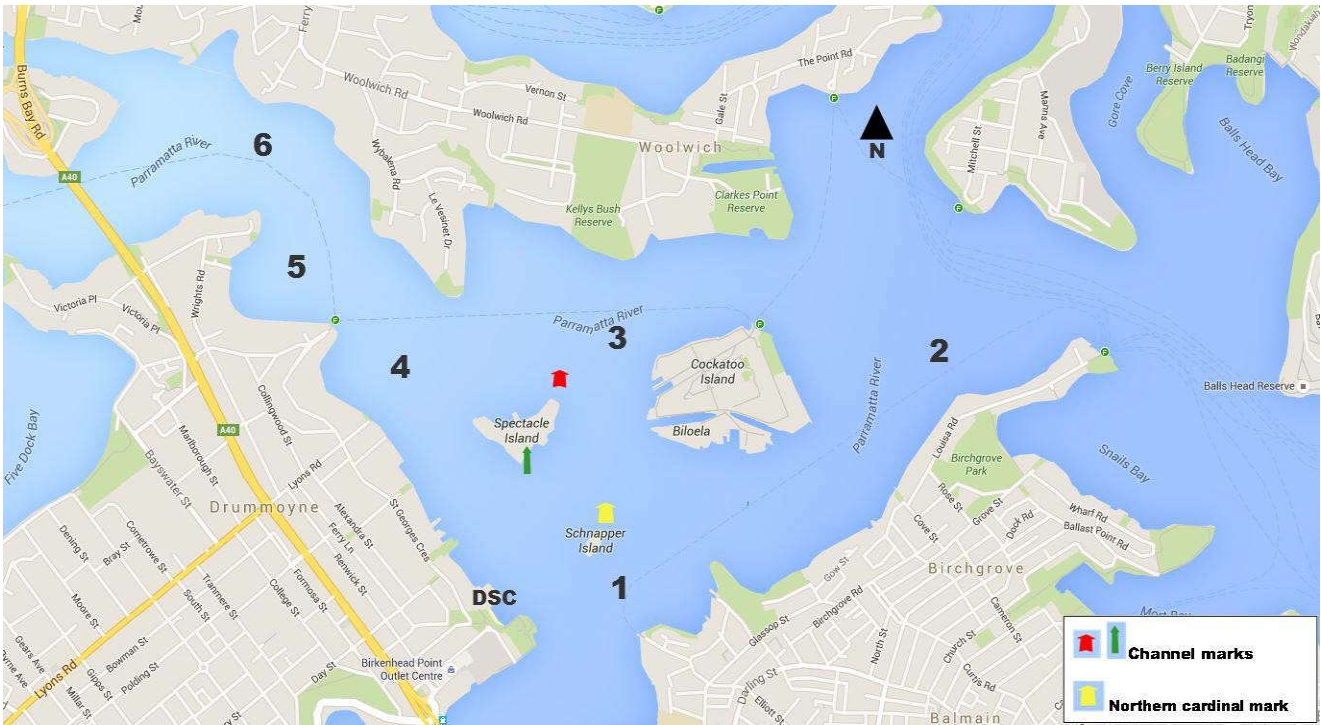

**Attachment A**  
**2017 - 2018 NSW and ACT Laser Metropolitan Championship**  
**Sailing Instructions**

**INSTRUCTION 10 COURSES**

The Course (as shown in Illustration 1 and described in Table 1 below) shall be displayed as a flag hoist of the numeral pennant, with Flag “J”  as required, on the Committee Vessel before or with the Warning Signal.

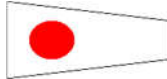
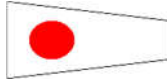
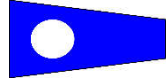
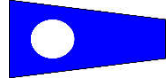
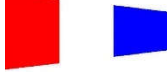
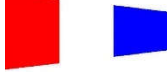
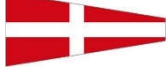
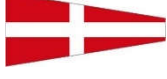

*Illustration 1 – Course Layout*

<b>1</b>	NE 	Start: to windward of Mark 1; then to: 2 (P), 3 (P), 1 (P), 2 (P), 1 (P), Finish to windward
<b>1J</b>		Start: to windward of Mark 1; then to: 2 (P), 3 (P), 1 (P), Finish to windward
<b>2</b>	E 	Start to windward of Mark 4; then to: 2 (S), 1 (S), 4 (S), Finish to windward
<b>2J</b>		Start to windward of Mark 4; then to: 2 (S), 1 (S), 4 (S), 2 (S), 4 (S), Finish to windward
<b>3</b>	S / SE 	Start to windward of Mark 6; then to: 1 (P), 3 (P), 6 (P), 1 (P), 6 (P), Finish to windward
<b>3J</b>		Start to windward of Mark 6; then to: 1 (P), 3 (P), 6 (P), Finish to windward
<b>4</b>	SW 	Start to windward of Mark 2; then to: 1 (S), 3 (S), 2 (S), Finish to windward
<b>4J</b>		Start to windward of Mark 2; then to: 1 (S), 3 (S), 2 (S), 1 (S), 2 (S), Finish to windward
<b>5</b>	W 	Start to windward of Mark 2; then to: 4 (P), 1 (P), 2 (P), 4 (P), 2 (P), Finish to windward
<b>5J</b>		Start to windward of Mark 2; then to: 4 (P), 1 (P), 2 (P), Finish to windward
<b>6</b>	NW 	Start to windward of Mark 1; then to: 5 (S), 3 (S), 1 (S), 5 (S), 1 (S), Finish to windward
<b>6J</b>		Start to windward of Mark 1; then to: 5 (S), 3 (S), 1 (S), Finish to windward

*Table 1 – Course Description*

**Attachment B**  
**2017 - 2018 NSW and ACT Laser Metropolitan Championship**  
**Sailing Instructions**

## **RMS Maritime - Yacht Person's Brief**

**1. Be Safe!**

**2. Observe NSW collision regulations and in particular Rule 1 (b) and Rule 2(a) (b) i.e.:**

Nothing in these Rules shall exonerate any vessel, or the owner, master or crew thereof, from the consequences of any neglect to comply with these Rules or of the neglect of any precaution which may be required by the ordinary practice of seamen, or by the special circumstances of the case.

In complying with these Rules due regard shall be had to all dangers of navigation and collision and to any special circumstances, including the limitations of the vessels involved, which may make a departure from these Rules necessary to avoid immediate danger.

What this means is that if you're about to be involved in a collision, having stood on or given way in accordance with the Rule, every party involved is responsible for taking avoiding action to prevent a collision.

Local Rules require sail craft to keep out of the way of ferries, naval vessels, seagoing ships and oil tankers. Pass the ferries clear at least 200m from the bow and 30m, either side and astern.

**3. Seagoing ships**

All craft are to keep 500m clear ahead and 30m clear of each side and stern of seagoing ships. In Sydney Harbour and Botany Bay, seagoing ships over 100m length are escorted by a Sydney Ports' vessel, orange hull and yellow superstructure with flashing red and blue lights. Craft are not to pass between the escort vessel and the seagoing ship under escort.

Be mindful of larger ships' bow flare. When closing any vessel, to prevent being overrun ensure you remain within sight of the Master/Officer of the Watch on the vessel's bridge. Beware of overhanging bows and other parts of ship that might obstruct this line of sight. This means that your vessel may disappear from sight inside 500m from the bows of very large ships.

**4. Shipping Sound Signal Meanings:**

One prolonged blast – I am approaching a bend or obscured area (blind spot).

One short blast – I am altering course to starboard (right).

Two short blasts – I am altering course to port (left).

Three short blasts – I am operating engines astern (stopping).

Five (or more) short blasts - I'm unsure of your intentions and I doubt whether you are taking enough avoiding action to avoid collision.

**5. When not racing keep at least 200m clear of any ferries displaying the Orange Diamond.**

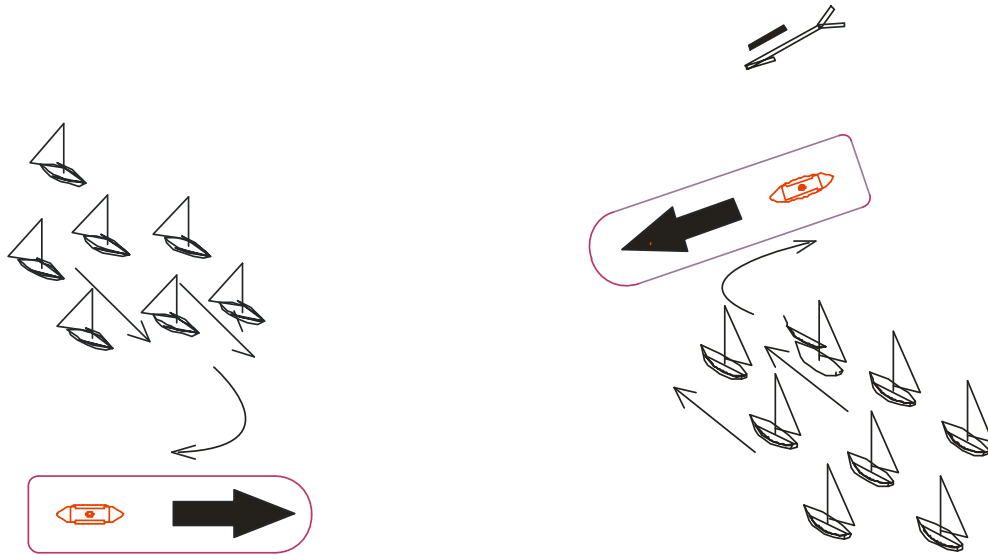
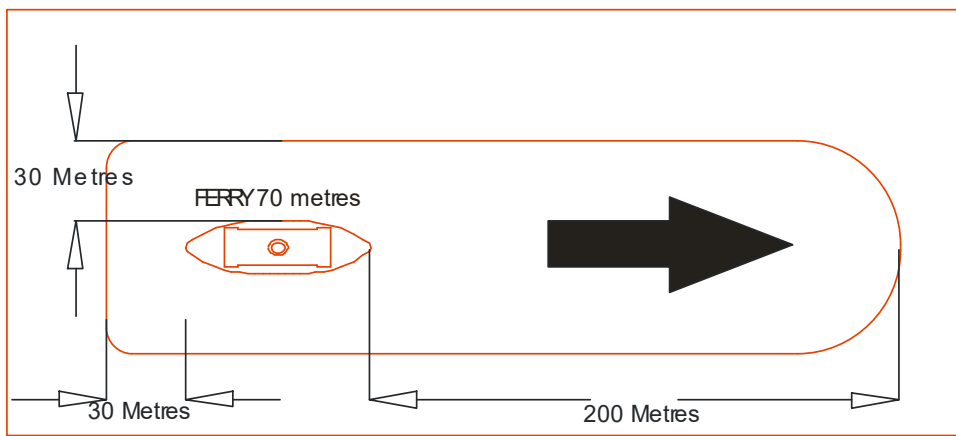
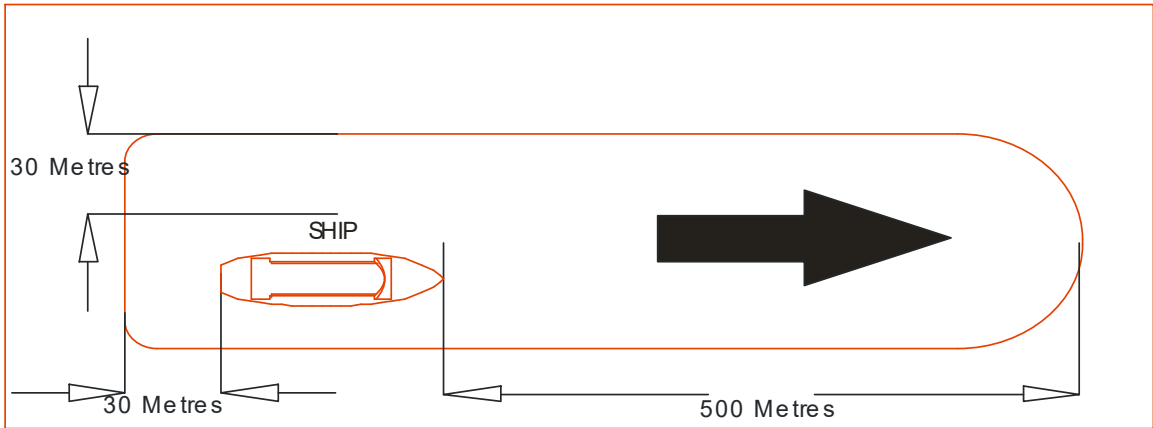

**SHIP & FERRY ACTIVATED  
EXCLUSION ZONE**